



THE **NEW** CONNECTED THERMOSTAT

Smarter

WITH
Netatmo

Essential design,
maximum comfort,
wherever you are.

Smarter
WITH
Netatmo

The BTicino connected thermostat monitors and manages the temperature of the home simply and timely. Thanks to the Home + Control App and the compatibility with voice assistants, it allows smart management of the home temperature.



BTicino connected thermostat,
developed jointly with Netatmo, forms
part of the Eliot by BTicino programme
dedicated to connected objects

DESIGN



3 colours for flush mounted version: white, black and sand

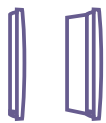

2 versions: flush mounted and wall mounted

COMFORT AND SAVING

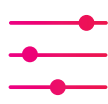

Easy heating system management and monitoring



Boost function for maximum comfort



Compatibility with Netatmo smart radiator valves for setting the desired temperature in every room

EASE OF USE



Basic functions with local device control



Advanced functions and programming with the Home + Control App



Basic functions with local voice assistant compatible control: Siri (Apple), Google Assistant, Amazon Alexa



Other smart home functions with
- Living Now with Netatmo
- Livinglight with Netatmo

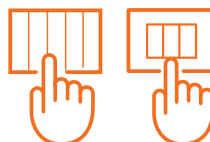



Essential design.
Modern style.



A minimal and refined design, in which the thickness and glass-effect finish make it versatile and suitable for any style of home. The metallised detail is a distinctive element which characterises the object and becomes an informative and enhancing element of the distinctive "Boost" function. At last, its discrete white light is decorative and informative, assisting the user in understanding and using the functions.

Smarter WITH Netatmo

The BTicino connected thermostat was conceived for integration with all living styles, and is perfectly coordinated with the Living Now range.

Living Now WITH Netatmo



Comfort and saving

What can you do with the BTicino connected thermostat?



SETTING THE PROGRAMS

Using the Home + Control App, it is possible to set preset programs based on your habits.



AWAY

If you need to be away from home for a few days you can, via the APP, act remotely to adjust the thermostat (e.g. in antifrost mode) independent of the automatic programming.



BOOST

The Boost function can be used to activate the heating or cooling system for a limited time (30, 60 or 90 minutes), irrespective of the set program and the ambient temperature.



App



Voice control



Device

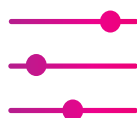

MONITORING OF CONSUMPTIONS

Using the Home + Control App, it is possible to easily manage and monitor consumptions.

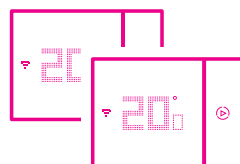

MAXIMUM COMFORT IN EVERY ZONE

Using the same App, it is possible to manage several thermostats in the same home or in different homes, as well as set the desired temperature in every room for maximum comfort.



Ease of use

The connected thermostat is simple and intuitive



LOCAL DEVICE CONTROL



VOICE CONTROL

It is also possible to manage the heating with your voice using voice control assistants.

Siri (Apple), Google Assistant, Amazon Alexa.

GOOGLE: "Set the kitchen to automatic"

AMAZON: "Alexa, increase the living room temperature by 3°C"

APPLE: "Siri, set the temperature to 20°C"



GEOLOCATION

When used in conjunction with voice assistants, it is possible to set the geolocalisation routine, which allows you to save energy by switching off the heating when you leave the home.



Display the temperature and set it as desired



Display the set room temperature and humidity



Activate the Boost function



Home + Control App

With the App it's all easier

- Remotely manage the thermostat simply and intuitively
- Create and modify the weekly programs
- Manage the thermostat from several smartphones and different users
- Control several thermostats in the same home or different homes
- Manage the thermostat updates

Home + Control App

In just a few steps you can already use the connected thermostat

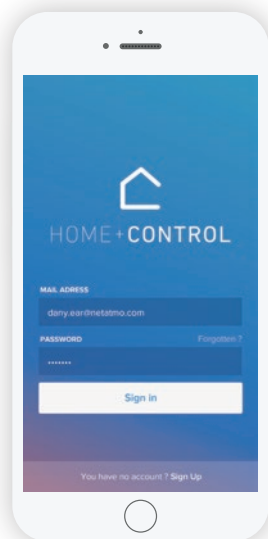

1

Download and install the Home + Control App

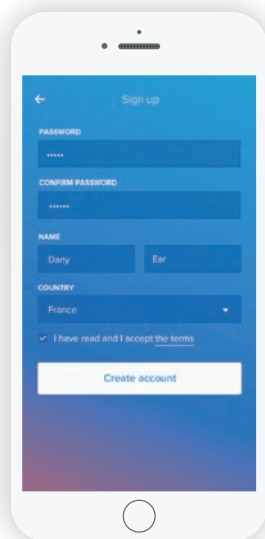

2

Create your account

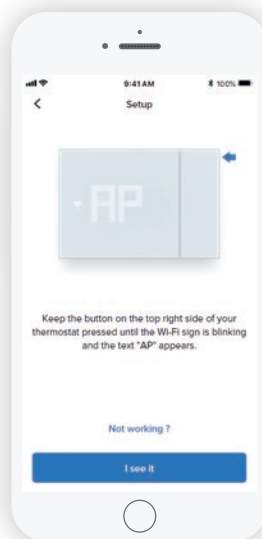

3

Connect the thermostat to the home wi-fi network

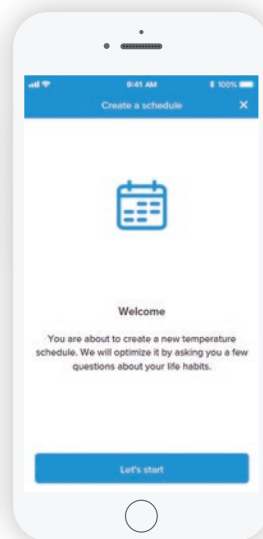

4

You can start to set the programs



SETTING THE PROGRAMS

- Select the guided procedure to set daily and weekly programs
- Set the desired temperature when at home, when away, or when sleeping
- The program is already active

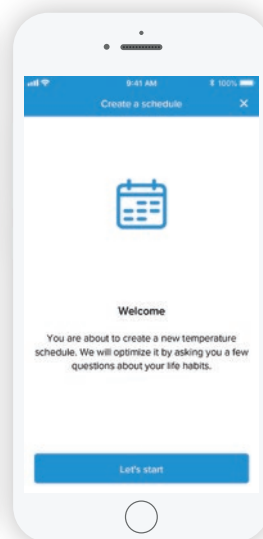
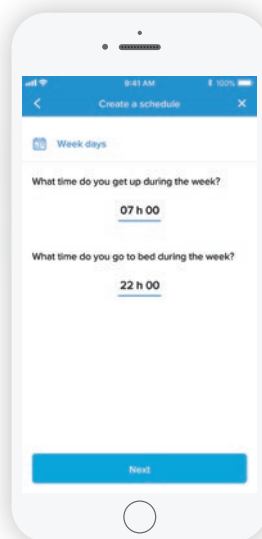

If necessary, you can call the BTicino after-sales service directly by means of the Help pushbutton integrated in the application, or by calling the free number 800-837035.



The Home + Control App is available on





AWAY

It is possible to control the home at any time:

- Changing the temperature or the set program
- Setting the away and frost-guard functions irrespective of the set program

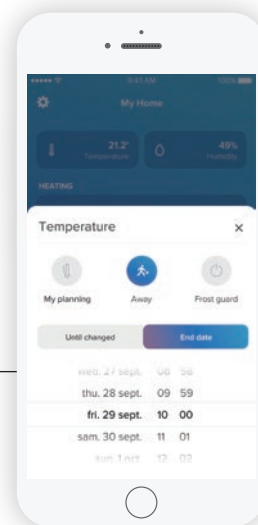

BOOST FUNCTION

Activate the heating or cooling for a limited time, regardless of the profile set and the room temperature.

At the end of the period of operation you can be certain that the heating or cooling will switch OFF.

- Click on the “Boost” function icon.
- Select the duration (30, 60, or 90 minutes) and confirm. Heating is ON.

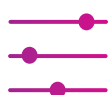

MONITORING OF CONSUMPTIONS

- An easy way to have always under control your heater consumption, tracking the temperature (room and set point) and the ON time of the heater

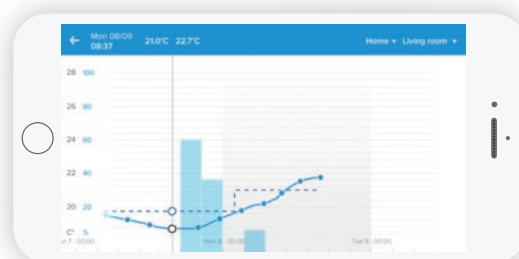

Maximum comfort in every zone

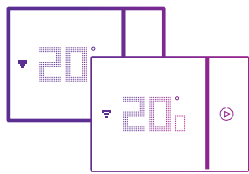

More thermostats?
More houses?

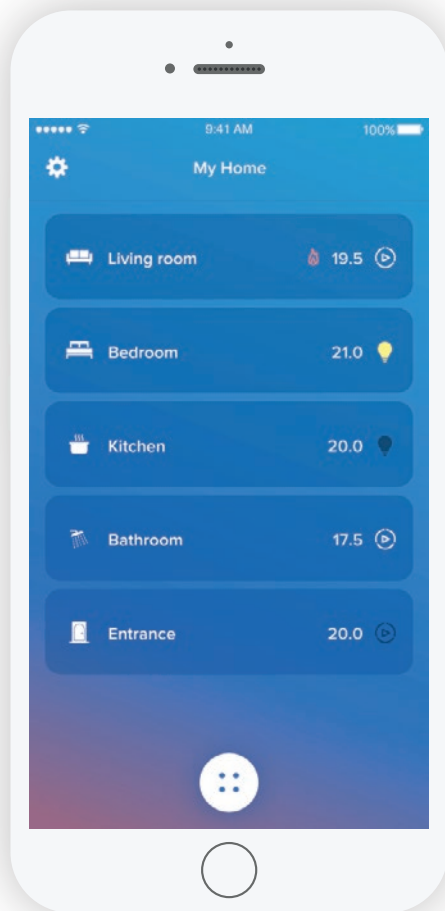

Management of several thermostats

As well as a single device you
can also manage:

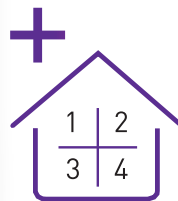

Several thermostats in the same
home (zone isolation of the system)

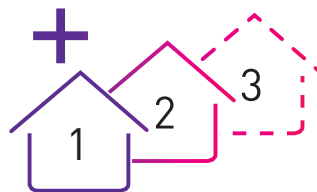

Thermostats in different buildings
(main home and second home)



Independent heating system with radiators?

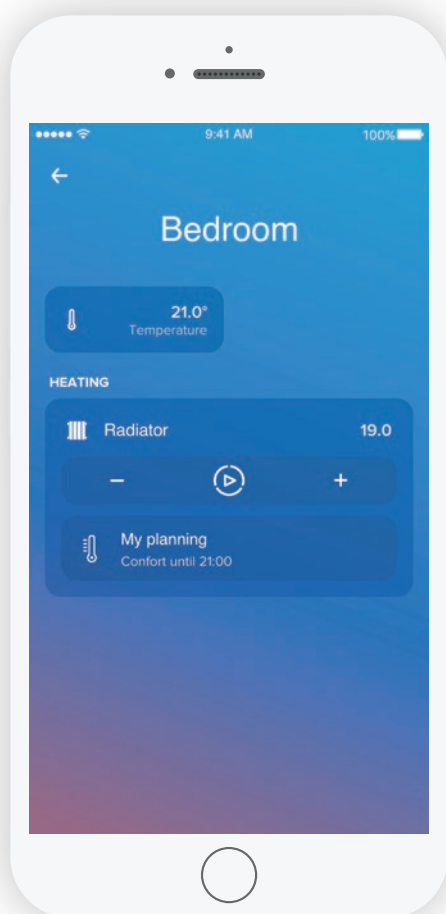

Management of the valves

Setting the temperature of every room with Smarter with Netatmo is not a problem:



Using the same Home + Control App, you can control and adjust the smart radiator valves installed on each radiator.



 Netatmo

Netatmo smart radiator valves

To know more visit Netatmo PRO at <https://pro.netatmo.com>



Home + Control

Just one App. Several connected advantages

Using the same Home + Control App, you can control the Living Now with Netatmo or Livinglight with Netatmo connected system

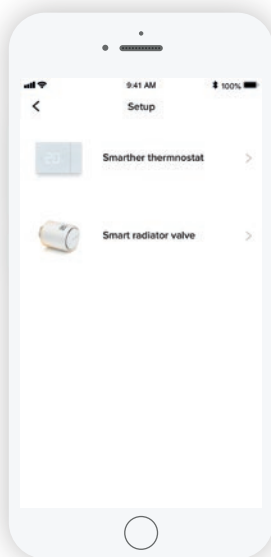
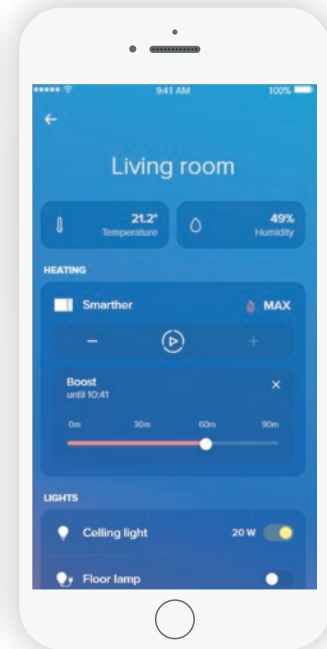
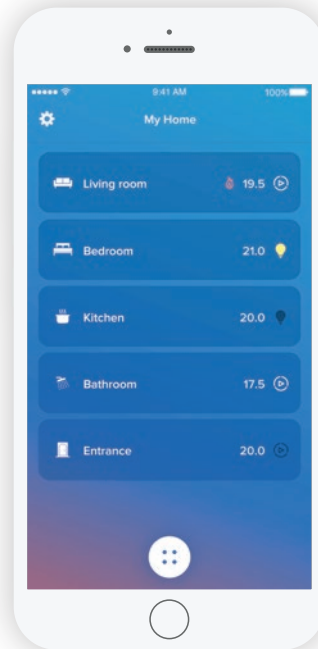

In this way, in addition to the connected thermostat, you can also manage the electric system of your home using the same App:

- Display and check the status of lights, shutters and loads connected to sockets
- Check and monitor your consumption trends
- Activate and customise your scenarios

Living Now WITH Netatmo

CONNECTED LIGHT POINT



Smarter WITH Netatmo

CONNECTED THERMOSTAT



CONNECTED SHUTTER CONTROL



SOCKET WITH CONNECTED MODULE



How to install it

Smarter with Netatmo flush mounted thermostat

Items XW8002 - XG8002 - XM8002

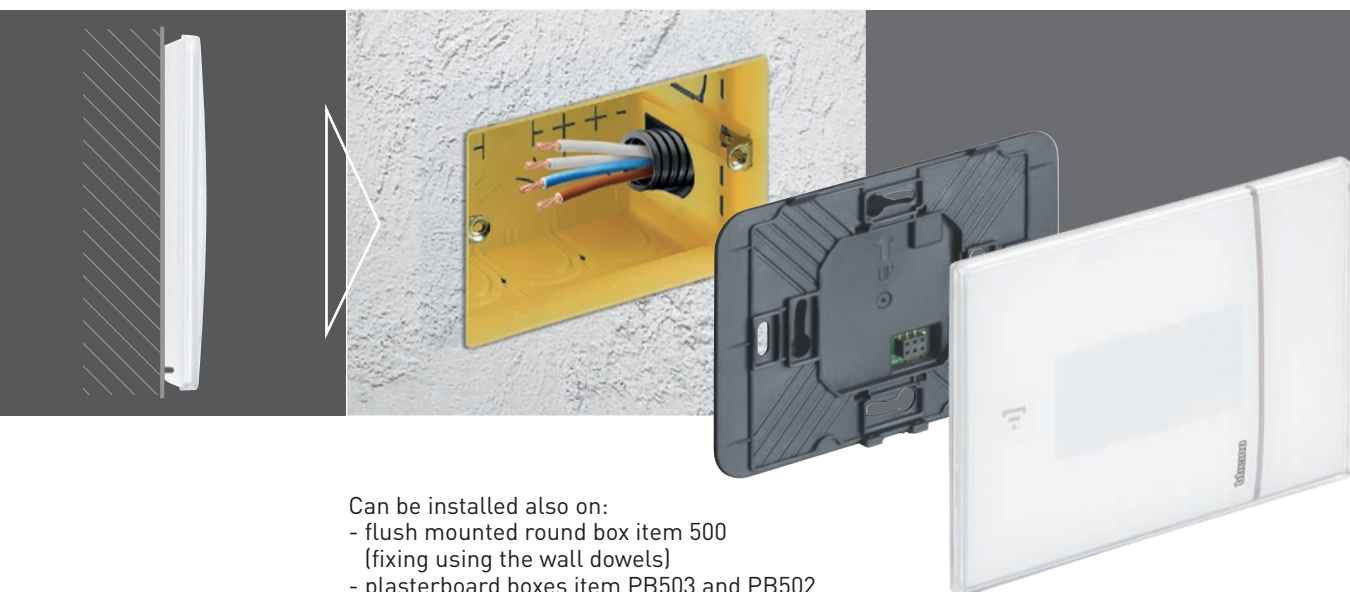

Can be installed also on:
- flush mounted round box item 500
(fixing using the wall dowels)
- plasterboard boxes item PB503 and PB502

Smarter with Netatmo wall mounted thermostat

Items XW8002W

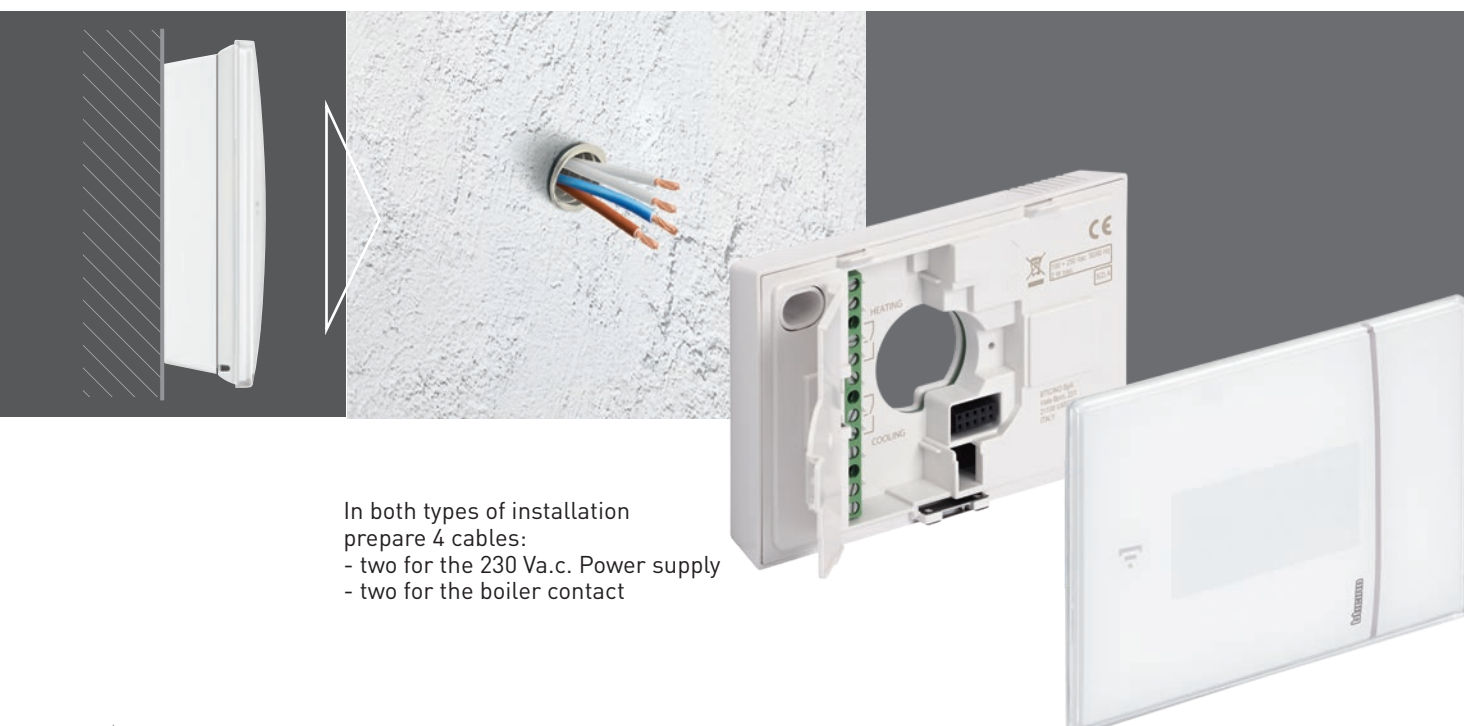

In both types of installation
prepare 4 cables:
- two for the 230 V.a.c. Power supply
- two for the boiler contact

Easily replace the old thermostat, whether flush or wall mounted, working with batteries or supplied at 230 Va.c.

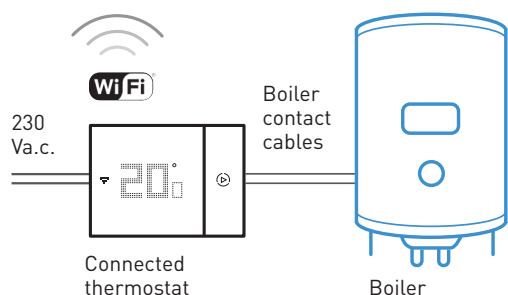

The new connected thermostat is the ideal solution for both new installations and to replace an old thermostat. Flush or wall mounted, the connected thermostat is easy to set up.

Only tip: when replacing an old battery thermostat, you will need two wires for the 230 V ac. power supply.



Wall mounted timer thermostat



Flush mounted timer thermostat



BTicino timer thermostat replaceable with the new connected thermostat

TABLE OF REPLACEABLE PRODUCTS

	AXOLUTE		LIVINGLIGHT		MÀTIX	
	Flush mounted	Wall mounted	Flush mounted	Wall mounted	Flush mounted	Wall mounted
Battery power supply*	HD/HC/HS4451		N/NT/L4451	N/NT/L4450	AM5721	N4450
	HC/HS4449		N/L4449			
230 Va.c. power supply			N/NT/L4448			

* Note: for battery devices you will need the wires for the 230 Va.c. power supply

YOU CAN ALSO REPLACE THE OLD CONNECTED THERMOSTAT WITH THE NEW SMARTER WITH NETATMO**

	SMARTER X8000 - X800W 	SMARTER WITH NETATMO XW8002-XM8002 XG8002-XW8002W 
Range	Flush mounted: white Wall mounted: white	Flush mounted: white, black and sand Wall mounted: white
App	Thermostat	Home + Control
Voice Control	Google Assistant and Amazon Alexa	Google Assistant, Amazon Alexan and Apple HomeKit
Geolocation	Using the dedicated App	Using the voice assistant App
Monitoring of Consumptions	No	Yes
Management of Netatmo radiator valves	No	Yes
Energy class	Class 1	Class 4

** Items X8000 and X8000W cannot be updated: to enjoy all the new functions they must be replaced with the new connected thermostats

Smarter with Netatmo

TERMOSTATO CONNESSO

Features and connections

Front view

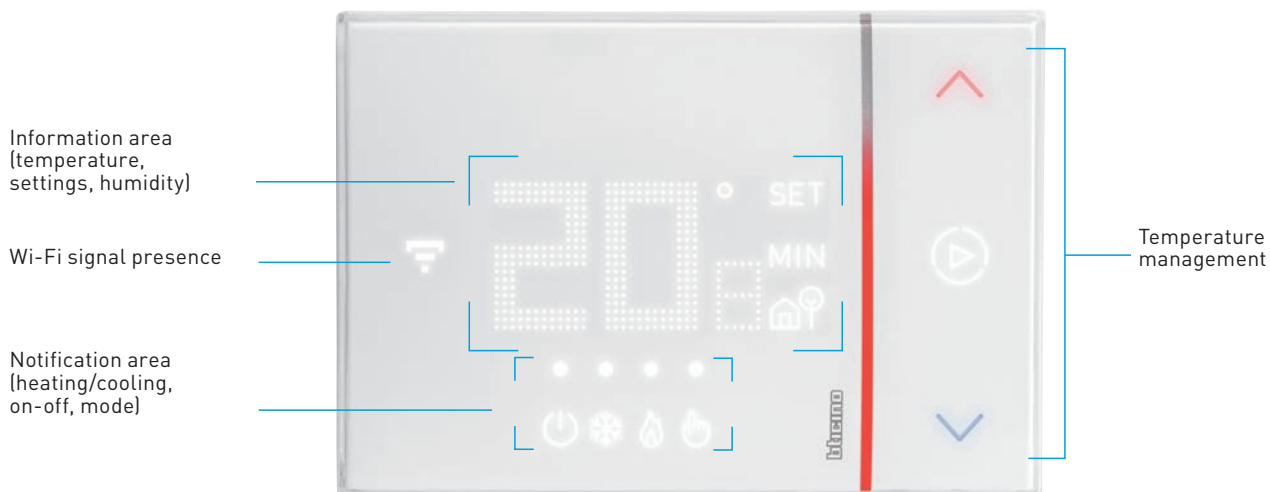

Rear view

FLUSH MOUNTED VERSION

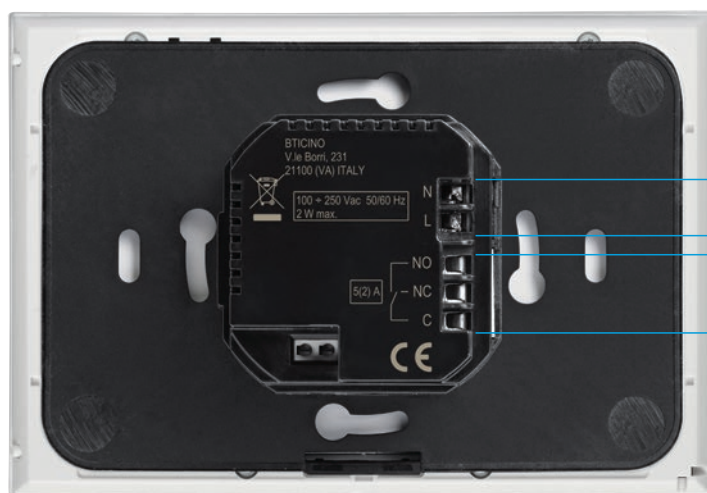

WALL MOUNTED VERSION

Power supply 230 Va.c.

Relay contacts (connections to boilers, air conditioning, radiator valves)

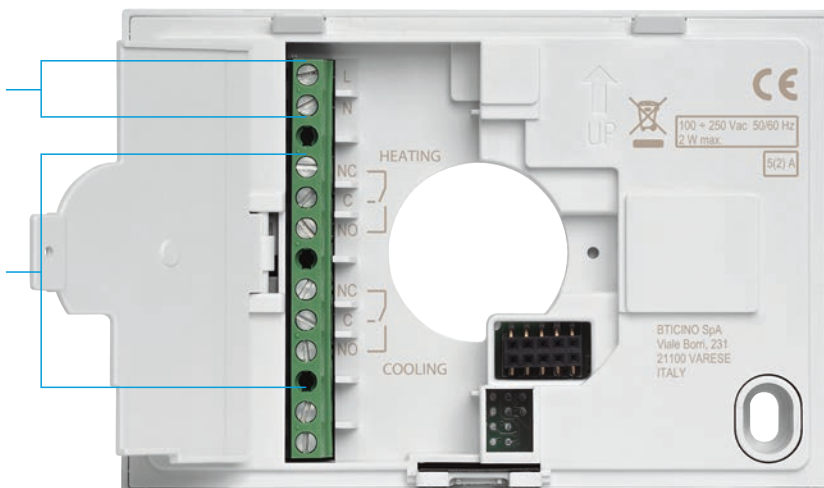

Smarter with Netatmo CONNECTED THERMOSTAT

eliot™ Catalogue



XW8002



XM8002



XG8002



XW8002W

Item **CONNECTED THERMOSTAT**

- XW8002
- XM8002
- XG8002

The Smarter with Netatmo connected thermostat, together with the Home + Control APP, is a device which allows you to adjust and monitor the temperature in the rooms precisely and accurately; all the programming and most of the functions are performed simply and intuitively using the APP.

Thanks to its Wi-Fi connection, Smarter can be programmed and controlled remotely; it can also display the temperature and humidity measured in the room. The temperature level can be set locally for manual operation and the Boost mode can be activated. The Boost forces the switching on of the system for a limited time (30, 60 or 90 minutes) independent of the measured and programmed temperature.

It's also possible to set a different temperature in each room of the house for the maximum comfort, thanks to its compatibility with Netatmo's smart radiator valves.

Smarter with Netatmo can also be controlled with Google, Amazon Alexa and Apple Home Kit voice assistants.

- Power supply 110 to 240 Vac , 50/60 Hz;
- 2 W max absorption;
- Maximum cable section 1 x 1.5 mm²;
- Operating temperature 5 to 40 °C;
- Temperature set-point 5 °C ÷ 40 °C;
- Increase of 0,5°C;
- 1-contact output in switching free of 5(2)A potential.
- Type of operation 1BU
- Pollution index 2
- Rated pulse voltage 4 kV
- Wireless device in compliance with 802.11b/g/n standard, frequency 2.4 - 2.4835 GHz, transmission power < 20 dBm. WPA/WPA2 safety protocol.

Types of installation

- flush mounted, on boxes item 503E or 500 (for item 500 use the wall dowels)

- plasterboard, on boxes item PB503 and PB502

It is available in three colours: white (XW8002), sand (XM8002) and black (XG8002).

- XW8002W Features: as XW8002. Installation: on the wall, using screws and dowels suitable for the installation surface (brickwork, plasterboard, tiles etc.). It is available only in white colour.

DIMENSIONAL DATA

Flush mounted version

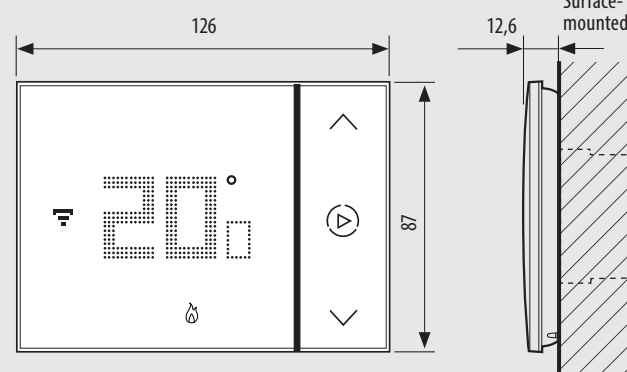

XW8002 - XM8002 - XG8002

Wall mounted version

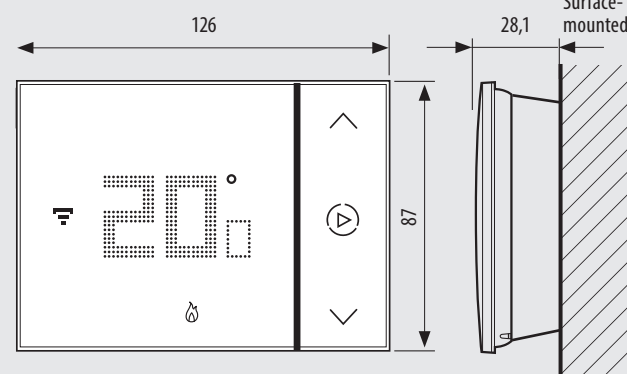

XW8002W

Size in mm



Home + Control App
for the management of connected devices



And if the internet does not work?
The thermostat continues to work in the room following the set program.
The App cannot be used remotely.



Smart has never been so easy

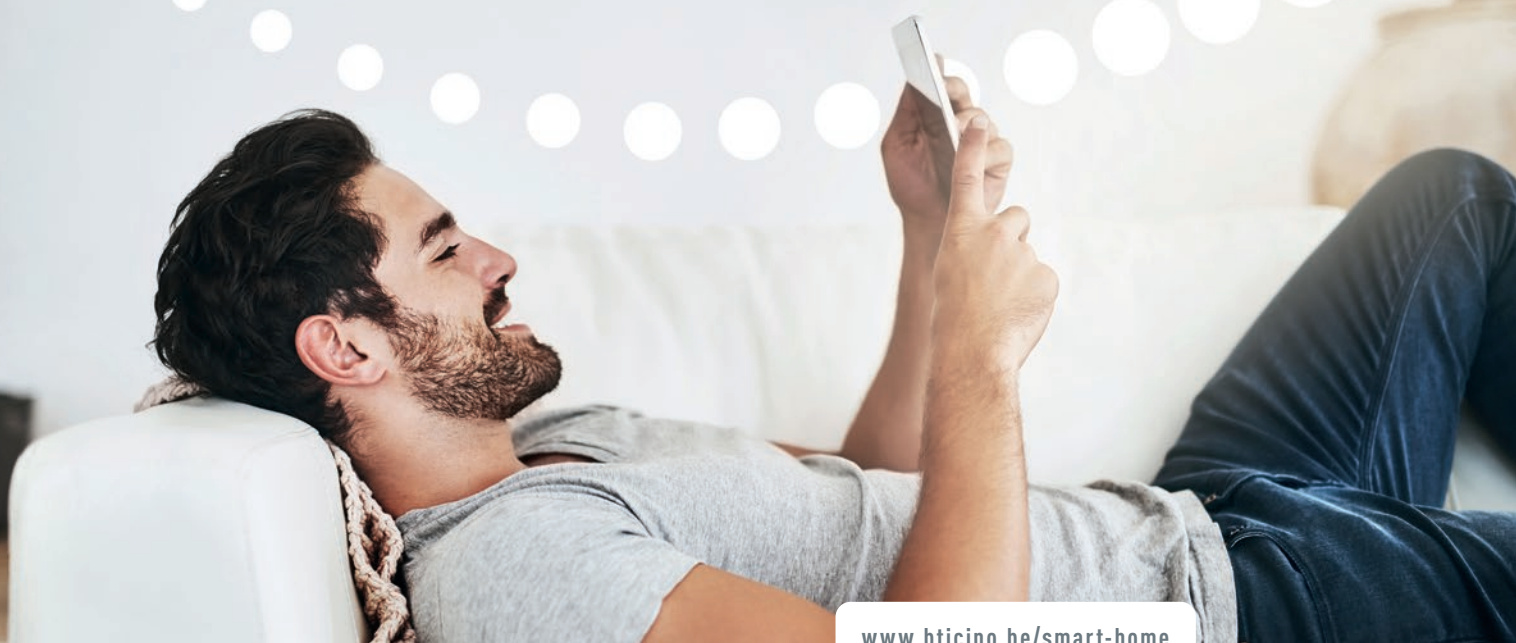

www.bticino.be/smart-home



bticino

A Group brand | **legrand**

Legrand Group Belgium nv/s.a.
Kouterveldstraat 9
1831 Diegem

T +32 (0)271917 111
F +32 (0)271917 00
E info.be@legrandgroup.be

FOLLOW US ALSO ON

 www.bticino.be - www.legrand.be
 www.ecataleg.be

**Visit the Concept Store
and discover all our solutions..** *(by appointment only)*
Kouterveldstraat 9, 1831 Diegem

Make an appointment:
T +32 (0)2 719 17 11

 www.bticino.be/concept-store